

# Lifecube Single-Use Transfer Sets

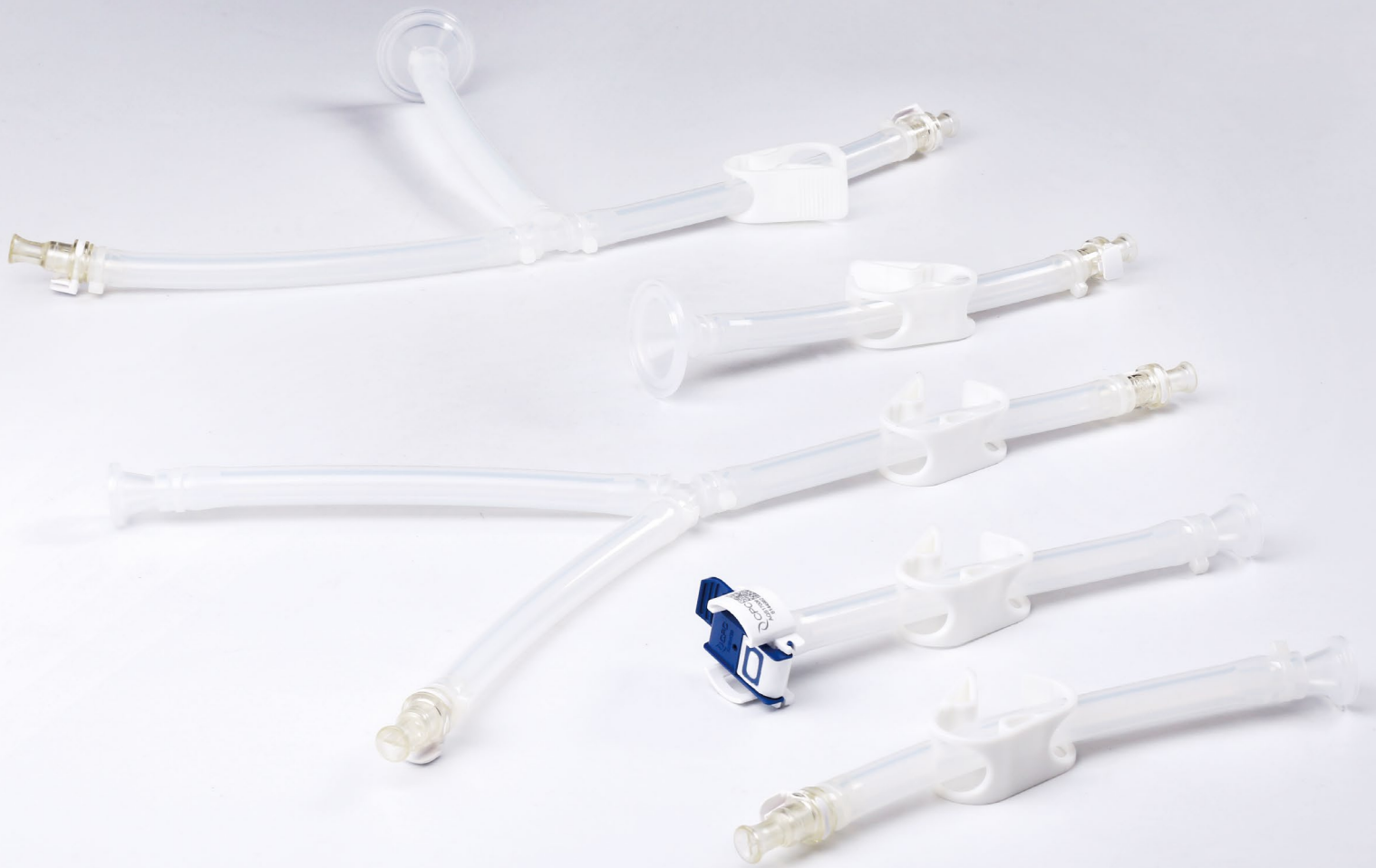

# Lifecube Single-Use Transfer Sets

Single-use tubing assemblies are critical for transfers between single-use and hybrid systems. With **Cobetter Single-use Transfer Sets**, you can easily connect multiple containers, vessels and process lines in one system. The extension set is available in a variety of tubing sizes and lengths to meet your fluid transfer needs.

**Lifemeta STT Silicone Tubing** is a highly resistant platinum-cured silicone tubing, with very low extractable for the transfer of critical fluids and suitable for pumping application.

**Lifemeta STF TPE Tubing** is a highly resistant sealable and weldable thermoplastic elastomer tubing, features smooth inner bore for superior fluid flow.



## Features

- Ready to use, saving time and reducing costs
- Streamline the collection and transfer of samples
- Minimizing the risk of cross-contamination
- Custom assemblies are available

## Applications

- Buffer and media transfer
- Collecting samples
- Media filtration
- Removal of liquids from bioprocess
- Carboy Assemblies
- Peristaltic Pump Tube assemblies

## Quality Assurance

- ISO 9001:2015 quality management system
- Manufactured in ISO Class 7 clean room
- 100% leak testing
- ADCF raw material, meets the FDA Indirect Food Additive requirements cited in 21 CFR 177-182
- Meets the requirement of USP <87> In Vitro Biological Reactivity Test
- Meets the criteria of the USP <88> Biological Reactivity Test for Class VI plastics
- Aqueous extraction contains < 0.25 EU/mL as determined by Limulus Amebocyte Lysate (LAL), USP <85>
- Particulate matter in the product eluent meets the requirements in USP <788> for large volume parenterals
- Verify gamma irradiation dose of sterile packaging according to ISO 11137

## // Single-Use Extension Transfer Sets with TPE Tubing Plugs



Part No.	Port 1	Tubing	Length	Port 2	Package
SAL01001			50 cm		1 set
SAL01002	Plug	ID1/8" * OD1/4" C-Flex® 374	100 cm	Plug	1 set
SAL01003			250 cm		1 set
SAL01004			50 cm		1 set
SAL01005	Plug	ID1/4" * OD7/16" C-Flex® 374	100 cm	Plug	1 set
SAL01006			250 cm		1 set
SAL01007			50 cm		1 set
SAL01008	Plug	ID3/8" * OD5/8" C-Flex® 374	100 cm	Plug	1 set
SAL01009			250 cm		1 set
SAL01010			50 cm		1 set
SAL01011	Plug	ID1/2" * OD3/4" C-Flex® 374	100 cm	Plug	1 set
SAL01012			250 cm		1 set
SAL01013			50 cm		1 set
SAL01014	Plug	ID1/8" * OD1/4" Lifemeta STF	100 cm	Plug	1 set
SAL01015			250 cm		1 set
SAL01016			50 cm		1 set
SAL01017	Plug	ID1/4" * OD7/16" Lifemeta STF	100 cm	Plug	1 set
SAL01018			250 cm		1 set
SAL01019			50 cm		1 set
SAL01020	Plug	ID3/8" * OD5/8" Lifemeta STF	100 cm	Plug	1 set
SAL01021			250 cm		1 set
SAL01022			50 cm		1 set
SAL01023	Plug	ID1/2" * OD3/4" Lifemeta STF	100 cm	Plug	1 set
SAL01024			250 cm		1 set

## // Single-Use Extension Transfer Sets with Lifemeta STT Pt-cured Silicone Tubing EC Connectors



Part No.	Port 1	Tubing	Length	Port 2	Package
SAL02019			50 cm		1 set
SAL02020	ECS Female	ID1/8" * OD1/4" Lifemeta STT	100 cm	ECS Male	1 set
SAL02021			250 cm		1 set
SAL02022			50 cm		1 set
SAL02023	ECS Female	ID1/4" * OD7/16" Lifemeta STT	100 cm	ECS Male	1 set
SAL02024			250 cm		1 set
SAL02025			50 cm		1 set
SAL02026	ECS Female	ID3/8" * OD5/8" Lifemeta STT	100 cm	ECS Male	1 set
SAL02027			250 cm		1 set
SAL02028			50 cm		1 set
SAL02029	ECM Female	ID1/2" * OD3/4" Lifemeta STT	100 cm	ECM Male	1 set
SAL02030			250 cm		1 set
SAL02031		ID1/8" * OD1/4" Lifemeta STT	100 cm		1 set
SAL02032	ECS Male	ID1/4" * OD7/16" Lifemeta STT	100 cm	TC25	1 set
SAL02033		ID3/8" * OD5/8" Lifemeta STT	100 cm		1 set
SAL02034		ID1/4" * OD7/16" Lifemeta STT	100 cm		1 set
SAL02035	ECS Male	ID3/8" * OD5/8" Lifemeta STT	100 cm	TC50	1 set
SAL02036	ECM Male	ID1/2" * OD3/4" Lifemeta STT	100 cm	TC50	1 set

## // Single-Use Extension Transfer Sets with Lifemeta STT Pt-cured Silicone Tubing AseptiQuik<sup>®</sup> G Sterile Connectors



Part No.	Port 1	Tubing	Length	Port 2	Package
SAL03019			50 cm		1 set
SAL03020		ID1/4" * OD7/16" Lifemeta STT	100 cm		1 set
SAL03021			250 cm		1 set
SAL03022			50 cm	ECS Male	1 set
SAL03023		ID3/8" * OD5/8" Lifemeta STT	100 cm		1 set
SAL03024	AseptiQuik <sup>®</sup> G Sterile Connectors		250 cm		1 set
SAL03025			50 cm		1 set
SAL03026		ID1/2" * OD3/4" Lifemeta STT	100 cm	ECM Male	1 set
SAL03027			250 cm		1 set
SAL03028			ID1/4" * OD7/16" Lifemeta STT	100 cm	
SAL03029		ID3/8" * OD5/8" Lifemeta STT	100 cm	TC25	1 set
SAL03030		ID1/4" * OD7/16" Lifemeta STT	100 cm		1 set
SAL03031		ID3/8" * OD5/8" Lifemeta STT	100 cm	TC50	1 set
SAL03032		ID1/2" * OD3/4" Lifemeta STT	100 cm		1 set

## // Single-Use Reduction Transfer Sets with TPE Tubing

Figure 1, with tubing plugs



Part No.	Port 1	Tubing	Length	Port 2	Package
SAL04001		ID1/8" * OD1/4" to ID1/4" * OD7/16", C-Flex® 374	50 cm x2		1 set
SAL04002		ID1/8" * OD1/4" to ID1/4" * OD7/16", C-Flex® 374	100 cm x2		1 set
SAL04003		ID1/8" * OD1/4" to ID3/8" * OD5/8", C-Flex® 374	50 cm x2		1 set
SAL04004		ID1/8" * OD1/4" to ID3/8" * OD5/8", C-Flex® 374	100 cm x2		1 set
SAL04005	Plug	ID1/4" * OD7/16" to ID3/8" * OD5/8", C-Flex® 374	50 cm x2	Plug	1 set
SAL04006		ID1/4" * OD7/16" to ID3/8" * OD5/8", C-Flex® 374	100 cm x2		1 set
SAL04007		ID1/4" * OD7/16" to ID1/2" * OD3/4", C-Flex® 374	50 cm x2		1 set
SAL04008		ID1/4" * OD7/16" to ID1/2" * OD3/4", C-Flex® 374	100 cm x2		1 set
SAL04009		ID3/8" * OD5/8" to ID1/2" * OD3/4", C-Flex® 374	50 cm x2		1 set
SAL04010		ID3/8" * OD5/8" to ID1/2" * OD3/4", C-Flex® 374	100 cm x2		1 set
SAL04031		ID1/8" * OD1/4" to ID1/4" * OD7/16", Lifemeta STF	50 cm x2		1 set
SAL04032		ID1/8" * OD1/4" to ID1/4" * OD7/16", Lifemeta STF	100 cm x2		1 set
SAL04033		ID1/8" * OD1/4" to ID3/8" * OD5/8", Lifemeta STF	50 cm x2		1 set
SAL04034		ID1/8" * OD1/4" to ID3/8" * OD5/8", Lifemeta STF	100 cm x2		1 set
SAL04035	Plug	ID1/4" * OD7/16" to ID3/8" * OD5/8", Lifemeta STF	50 cm x2	Plug	1 set
SAL04036		ID1/4" * OD7/16" to ID3/8" * OD5/8", Lifemeta STF	100 cm x2		1 set
SAL04037		ID1/4" * OD7/16" to ID1/2" * OD3/4", Lifemeta STF	50 cm x2		1 set
SAL04038		ID1/4" * OD7/16" to ID1/2" * OD3/4", Lifemeta STF	100 cm x2		1 set
SAL04039		ID3/8" * OD5/8" to ID1/2" * OD3/4", Lifemeta STF	50 cm x2		1 set
SAL04040		ID3/8" * OD5/8" to ID1/2" * OD3/4", Lifemeta STF	100 cm x2		1 set

Figure 2, with EC connectors



Part No.	Port 1	Tubing	Length	Port 2	Package
SAL04011		ID1/8" * OD1/4" to ID1/4" * OD7/16", C-Flex® 374	50 cm x2		1 set
SAL04012		ID1/8" * OD1/4" to ID1/4" * OD7/16", C-Flex® 374	100 cm x2		1 set
SAL04013		ID1/8" * OD1/4" to ID3/8" * OD5/8", C-Flex® 374	50 cm x2	ECS Male	1 set
SAL04014		ID1/8" * OD1/4" to ID3/8" * OD5/8", C-Flex® 374	100 cm x2		1 set
SAL04015	ECS	ID1/4" * OD7/16" to ID3/8" * OD5/8", C-Flex® 374	50 cm x2		1 set
SAL04016	Female	ID1/4" * OD7/16" to ID3/8" * OD5/8", C-Flex® 374	100 cm x2		1 set
SAL04017		ID1/4" * OD7/16" to ID1/2" * OD3/4", C-Flex® 374	50 cm x2		1 set
SAL04018		ID1/4" * OD7/16" to ID1/2" * OD3/4", C-Flex® 374	100 cm x2	ECM	1 set
SAL04019		ID3/8" * OD5/8" to ID1/2" * OD3/4", C-Flex® 374	50 cm x2	Male	1 set
SAL04020		ID3/8" * OD5/8" to ID1/2" * OD3/4", C-Flex® 374	100 cm x2		1 set
SAL04041		ID1/8" * OD1/4" to ID1/4" * OD7/16", Lifemeta STF	50 cm x2		1 set
SAL04042		ID1/8" * OD1/4" to ID1/4" * OD7/16", Lifemeta STF	100 cm x2		1 set
SAL04043		ID1/8" * OD1/4" to ID3/8" * OD5/8", Lifemeta STF	50 cm x2	ECS Male	1 set
SAL04044		ID1/8" * OD1/4" to ID3/8" * OD5/8", Lifemeta STF	100 cm x2		1 set
SAL04045	ECS	ID1/4" * OD7/16" to ID3/8" * OD5/8", Lifemeta STF	50 cm x2		1 set
SAL04046	Female	ID1/4" * OD7/16" to ID3/8" * OD5/8", Lifemeta STF	100 cm x2		1 set
SAL04047		ID1/4" * OD7/16" to ID1/2" * OD3/4", Lifemeta STF	50 cm x2		1 set
SAL04048		ID1/4" * OD7/16" to ID1/2" * OD3/4", Lifemeta STF	100 cm x2	ECM	1 set
SAL04049		ID3/8" * OD5/8" to ID1/2" * OD3/4", Lifemeta STF	50 cm x2	Male	1 set
SAL04050		ID3/8" * OD5/8" to ID1/2" * OD3/4", Lifemeta STF	100 cm x2		1 set

Figure 3, with TC connectors

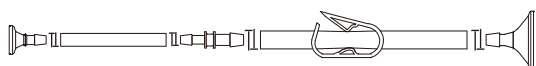

Part No.	Port 1	Tubing	Length	Port 2	Package
SAL04021		ID1/8" * OD1/4" to ID1/4" * OD7/16", C-Flex® 374	50 cm x2		1 set
SAL04022		ID1/8" * OD1/4" to ID1/4" * OD7/16", C-Flex® 374	100 cm x2		1 set
SAL04023		ID1/8" * OD1/4" to ID3/8" * OD5/8", C-Flex® 374	50 cm x2		1 set
SAL04024		ID1/8" * OD1/4" to ID3/8" * OD5/8", C-Flex® 374	100 cm x2		1 set
SAL04025	TC25	ID1/4" * OD7/16" to ID3/8" * OD5/8", C-Flex® 374	50 cm x2	TC50	1 set
SAL04026		ID1/4" * OD7/16" to ID3/8" * OD5/8", C-Flex® 374	100 cm x2		1 set
SAL04027		ID1/4" * OD7/16" to ID1/2" * OD3/4", C-Flex® 374	50 cm x2		1 set
SAL04028		ID1/4" * OD7/16" to ID1/2" * OD3/4", C-Flex® 374	100 cm x2		1 set
SAL04029		ID3/8" * OD5/8" to ID1/2" * OD3/4", C-Flex® 374	50 cm x2		1 set
SAL04030		ID3/8" * OD5/8" to ID1/2" * OD3/4", C-Flex® 374	100 cm x2		1 set
SAL04051		ID1/8" * OD1/4" to ID1/4" * OD7/16", Lifemeta STF	50 cm x2		1 set
SAL04052		ID1/8" * OD1/4" to ID1/4" * OD7/16", Lifemeta STF	100 cm x2		1 set
SAL04053		ID1/8" * OD1/4" to ID3/8" * OD5/8", Lifemeta STF	50 cm x2		1 set
SAL04054		ID1/8" * OD1/4" to ID3/8" * OD5/8", Lifemeta STF	100 cm x2		1 set
SAL04055	TC25	ID1/4" * OD7/16" to ID3/8" * OD5/8", Lifemeta STF	50 cm x2	TC50	1 set
SAL04056		ID1/4" * OD7/16" to ID3/8" * OD5/8", Lifemeta STF	100 cm x2		1 set
SAL04057		ID1/4" * OD7/16" to ID1/2" * OD3/4", Lifemeta STF	50 cm x2		1 set
SAL04058		ID1/4" * OD7/16" to ID1/2" * OD3/4", Lifemeta STF	100 cm x2		1 set
SAL04059		ID3/8" * OD5/8" to ID1/2" * OD3/4", Lifemeta STF	50 cm x2		1 set
SAL04060		ID3/8" * OD5/8" to ID1/2" * OD3/4", Lifemeta STF	100 cm x2		1 set



## // Single-Use Pump Tubing Sets with TPE Tubing

Figure 1, with tubing plugs



Part No.	Port 1	Tubing	Length	Port 2	Package
SAL05001	Plug	ID1/8" * OD1/4"	25 cm C-Flex® 374 to 50 cm Pharma APT to 25 cm C-Flex® 374	Plug	1 set
SAL05002		ID1/4" * OD7/16"	25 cm C-Flex® 374 to 50 cm Pharma APT to 25 cm C-Flex® 374		1 set
SAL05003		ID3/8" * OD5/8"	25 cm C-Flex® 374 to 50 cm Pharma APT to 25 cm C-Flex® 374		1 set
SAL05004		ID1/2" * OD3/4"	25 cm C-Flex® 374 to 50 cm Pharma APT to 25 cm C-Flex® 374		1 set
SAL05009	Plug	ID1/8" * OD1/4"	25 cm Lifemeta STF to 50 cm Pharma APT to 25 cm Lifemeta STF	Plug	1 set
SAL05010		ID1/4" * OD7/16"	25 cm Lifemeta STF to 50 cm Pharma APT to 25 cm Lifemeta STF		1 set
SAL05011		ID3/8" * OD5/8"	25 cm Lifemeta STF to 50 cm Pharma APT to 25 cm Lifemeta STF		1 set
SAL05012		ID1/2" * OD3/4"	25 cm Lifemeta STF to 50 cm Pharma APT to 25 cm Lifemeta STF		1 set

Figure 2, with EC connectors



Part No.	Port 1	Tubing	Length	Port 2	Package
SAL05005	ECS Female	ID1/8" * OD1/4"	25 cm C-Flex® 374 to 50 cm Pharma APT to 25 cm C-Flex® 374	ECS Male	1 set
SAL05006		ID1/4" * OD7/16"	25 cm C-Flex® 374 to 50 cm Pharma APT to 25 cm C-Flex® 374		1 set
SAL05007		ID3/8" * OD5/8"	25 cm C-Flex® 374 to 50 cm Pharma APT to 25 cm C-Flex® 374		1 set
SAL05008	ECM Female	ID1/2" * OD3/4"	25 cm C-Flex® 374 to 50 cm Pharma APT to 25 cm C-Flex® 374	ECM Male	1 set
SAL05013	ECS Female	ID1/8" * OD1/4"	25 cm Lifemeta STF to 50 cm Pharma APT to 25 cm Lifemeta STF	ECS Male	1 set
SAL05014		ID1/4" * OD7/16"	25 cm Lifemeta STF to 50 cm Pharma APT to 25 cm Lifemeta STF		1 set
SAL05015		ID3/8" * OD5/8"	25 cm Lifemeta STF to 50 cm Pharma APT to 25 cm Lifemeta STF		1 set
SAL05016	ECM Female	ID1/2" * OD3/4"	25 cm Lifemeta STF to 50 cm Pharma APT to 25 cm Lifemeta STF	ECM Male	1 set

## // Single-Use Y-line Transfer Sets with TPE Tubing

Figure 1, with tubing plugs

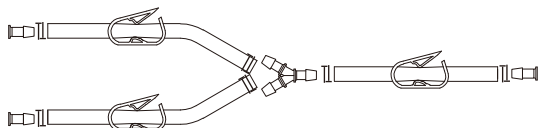

Part No.	Port 1	Tubing	Length	Port 2	Package
SAY01001	Plug	ID1/8" * OD1/4" C-Flex® 374	50 cm x3	Plug x2	1 set
SAY01002		ID1/4" * OD7/16" C-Flex® 374	50 cm x3		1 set
SAY01003		ID3/8" * OD5/8" C-Flex® 374	50 cm x3		1 set
SAY01004		ID1/2" * OD3/4" C-Flex® 374	50 cm x3		1 set
SAY01005	Plug	ID1/8" * OD1/4" Lifemeta STF	50 cm x3	Plug x2	1 set
SAY01006		ID1/4" * OD7/16" Lifemeta STF	50 cm x3		1 set
SAY01007		ID3/8" * OD5/8" Lifemeta STF	50 cm x3		1 set
SAY01008		ID1/2" * OD3/4" Lifemeta STF	50 cm x3		1 set

Figure 2, with EC connectors

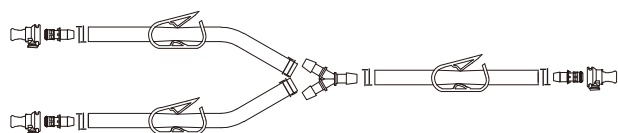

Part No.	Port 1	Tubing	Length	Port 2	Package
SAY02005	ECS Female	ID1/8" * OD1/4" Lifemeta STT	50 cm x3	ECS Male x2	1 set
SAY02006		ID1/4" * OD7/16" Lifemeta STT	50 cm x3		1 set
SAY02007		ID3/8" * OD5/8" Lifemeta STT	50 cm x3		1 set
SAY02008	ECM Female	ID1/2" * OD3/4" Lifemeta STT	50 cm x3	ECM Female x2	1 set

Figure 3, with TC connectors

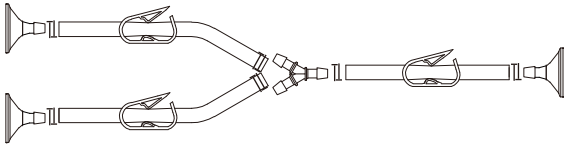

Part No.	Port 1	Tubing	Length	Port 2	Package
SAY03010		ID1/8" * OD1/4" Lifemeta STT	50 cm x3		1 set
SAY03011		ID1/4" * OD7/16" Lifemeta STT	50 cm x3		1 set
SAY03012	TC25	ID3/8" * OD5/8" Lifemeta STT	50 cm x3	TC25 x2	1 set
SAY03013		ID1/2" * OD3/4" Lifemeta STT	50 cm x3		1 set
SAY03014		ID3/4" * OD1" Lifemeta STT	50 cm x3		1 set
SAY03015		ID1/4" * OD7/16" Lifemeta STT	50 cm x3		1 set
SAY03016	TC50	ID3/8" * OD5/8" Lifemeta STT	50 cm x3	TC50 x2	1 set
SAY03017		ID1/2" * OD3/4" Lifemeta STT	50 cm x3		1 set
SAY03018		ID3/4" * OD1" Lifemeta STT	50 cm x3		1 set

Figure 4, with AseptiQuik® G Sterile connectors

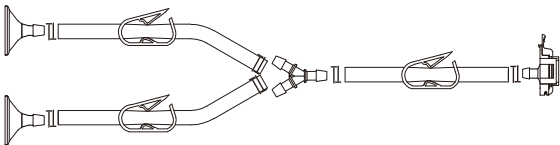

Part No.	Port 1	Tubing	Length	Port 2	Package
SAY05013		ID1/4" * OD7/16" Lifemeta STT	50 cm x3		1 set
SAY05014		ID3/8" * OD5/8" Lifemeta STT	50 cm x3	AseptiQuik® G x2	1 set
SAY05015		ID1/2" * OD3/4" Lifemeta STT	50 cm x3		1 set
SAY05016		ID1/4" * OD7/16" Lifemeta STT	50 cm x3	ECS Male+	1 set
SAY05017	AseptiQuik® G	ID3/8" * OD5/8" Lifemeta STT	50 cm x3	ECS Female	1 set
SAY05018		ID1/2" * OD3/4" Lifemeta STT	50 cm x3	ECM Male+ECM Female	1 set
SAY05019		ID1/4" * OD7/16" Lifemeta STT	50 cm x3		1 set
SAY05020		ID3/8" * OD5/8" Lifemeta STT	50 cm x3	TC25 x2	1 set
SAY05021		ID1/2" * OD3/4" Lifemeta STT	50 cm x3		1 set

# Our Mission

Through innovative, cost-efficient, and sustainable filtration solutions, we help our customers enhance human and animal welfare.

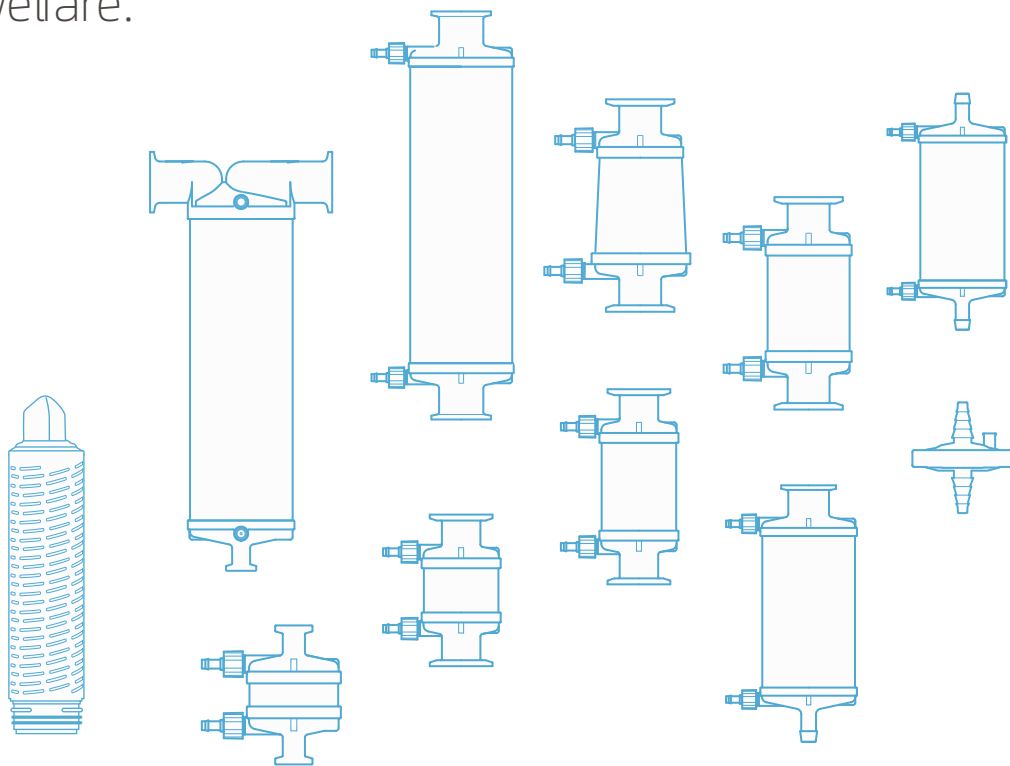

## Hangzhou Cobetter Filtration Equipment Co.,Ltd.

Sales Add 13-18 F, Building 1, Zicheng International Innovation Center,  
No.39 Jincheng Road, Xiaoshan District, Hangzhou 311215, China

Factory Cobetter Park, Heshang New Material Industrial Park,  
Xiaoshan District, Hangzhou 311265, China

Tel +86 571 87704359

Fax +86 571-87704256

eShop [www.cobetter.com](http://www.cobetter.com)